

2-way Control Valves type M1F

Cast iron, PN 16, DN 15/4 – 50 mm

2.3.02-L

GB-1

Characteristics

- Nominal pressure PN 16
- Regulating capability $\frac{k_{vs}}{k_{vr}} > 25$
- Single-seated, tightly closing
- Quadratic characteristic

Applications

Control valves type M1F are designed for regulating low, medium and high pressure hot water, steam and lubricating oils.

The valves are used in conjunction with our temperature or pressure differential regulators for controlling industrial processes, district or central heating plants or marine installations.

Dimensioning

For sizing of control valves and selection of actuators, please see "Quick Choice" leaflet no. 9.0.00.

Design

The valve components - spindle, seat and cone - are made of stainless steel.

The valve body is made of cast iron EN-GJS-400-15 with flanges drilled according to EN 1092-2. The thread for the actuator connection is G1B ISO 228. The valves are single-seated and designed for tight closure. The leakage rate is less than 0.05% of the full flow (according to VDI/VDE 2174).

Quality assurance

All valves are manufactured under an ISO 9001 certification and are pressure and leakage tested before shipment.

Function

Without the actuator being connected, the valve is held in open position by means of a spring. With pressure on the spindle the valve will close.

In connection with our thermostats or electronic actuators, the valves will close at rising temperatures. For cooling circuits a reverse acting valve can be used.

The quadratic characteristic will not cease until the flow has dropped below 4% of the full flow.

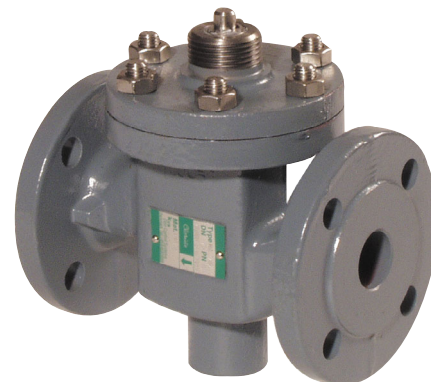

Technical data

Materials:	Cast iron
- Valve body	EN-GJS-400-15
- Components	Stainless steel
- Bolts, nuts	24 CrMo 4/A4
Nominal pressure	PN 16
Seating	Single-seated
Valve characteristic	Quadratic
Regulating capability	$\frac{k_{vs}}{k_{vr}} > 25$
Seat leakage	$\leq 0.05\%$ of k_{vs}
Temperature range	See diagram
Mounting	See page 2
Flanged ends	
drilled according to	EN 1092-2 PN 16
Counter flanges	DIN 2633/BS 4504
Colour	Grey

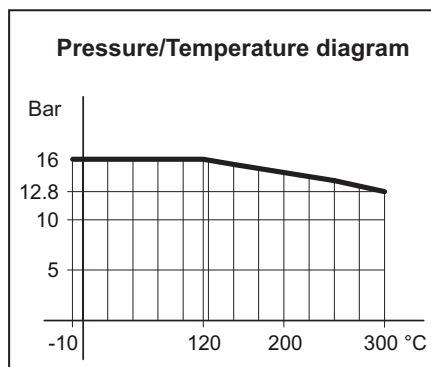

Specifications

Type	Flange connection DN in mm	Opening mm	k_{vs} -value m ³ /h	Lifting height mm	Weight kg
15/4 M1F	15	4	0.20	6	3
15/6 M1F	15	6	0.45	6	3
15/9 M1F	15	9	0.95	6	3.1
15/12 M1F	15	12	1.70	6	3.1
15 M1F	15	15	2.75	6	3.1
20 M1F	20	20	5	6.5	4.2
25 M1F	25	25	7.50	7	5.5
32 M1F	32	32	12.50	8	8.1
40 M1F	40	40	20	9	9.7
50 M1F	50	50	30	10	14

Subject to changes without notice.

2-way Control Valves type M1F

Cast iron, PN 16, DN 15/4 – 50 mm

2.3.02-L

GB-2

Definition of k_{VS} -value

The k_{VS} -value is identical to the IEC flow coefficient k_V and defined as the water flow rate in m^3/h through the fully open valve by a constant differential pressure, Δp_v , of 1 bar.

Mounting

Up to 170°C the valve can be installed vertically as well as horizontally. For media temperature above 170°C, a cooling unit of type KS has to be applied. It must then be installed with actuator/thermostats downwards, and according to the following instructions:

Valve Temperature	Cooling Unit	Suitable for
170°C - 250°C	KS-4	All actuators
250°C - 300°C	KS-5	Thermostats
250°C - 300°C	KS-6	Valve Motors

Strainer

It is recommended to use a strainer in front of the control valve if the liquid contains suspended particles.

Accessories

Manual Adjusting Device

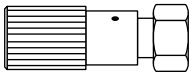

The device has a built-in stuffing box. For sealing and manual operation of valves when an actuator has not been fitted, e.g. during periods of construction.

Cooling Unit KS-4

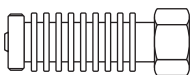

Cooling unit protecting the stuffing box of the motor/thermostat. To be applied at valve temperatures between 170°C and 250°C.

Cooling Unit KS-5

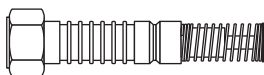

Cooling units with built-in bellow glands, replacing stuffing box of thermostat (KS-5) or valve motor (KS-6). Must be applied at valve temperatures above 250°C.

Cooling Unit KS-6

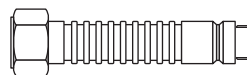

Subject to changes without notice.

Dimension sketch

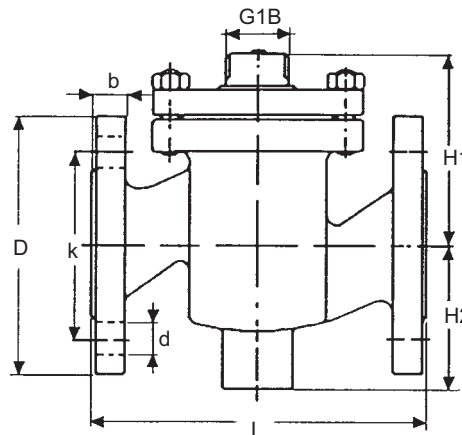

Type	L mm	H1 mm	H2 mm	b mm	D (dia.) mm	k (dia.) mm	d mm dia. (number)
15/4 M1F	130	80	60	14	95	65	14 x (4)
15/6 M1F	130	80	60	14	95	65	14 x (4)
15/9 M1F	130	80	60	14	95	65	14 x (4)
15/12 M1F	130	80	60	14	95	65	14 x (4)
15 M1F	130	80	60	14	95	65	14 x (4)
20 M1F	150	85	65	16	105	75	14 x (4)
25 M1F	160	95	70	16	115	85	14 x (4)
32 M1F	180	105	75	18	140	100	18 x (4)
40 M1F	200	110	85	18	150	110	18 x (4)
50 M1F	230	125	95	20	165	125	18 x (4)