

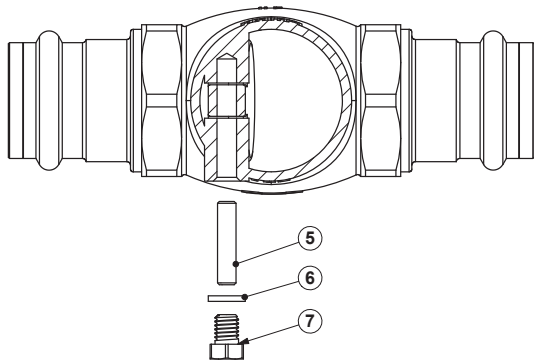

PN16 Brass Swing Check Valve

Features

- 'M' Press Ends
- Brass Body
- EPDM 'O' Rings
- Pre Press Leak Detection

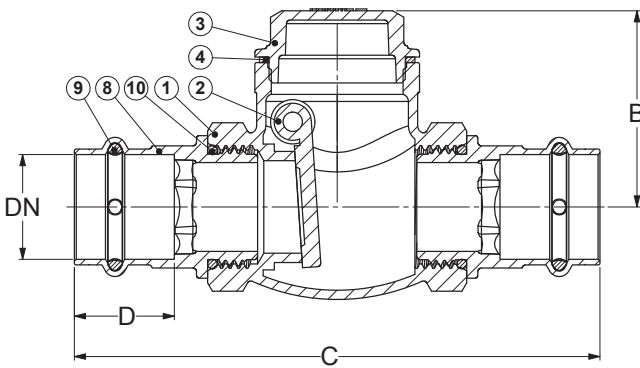

Pressure / Temperature

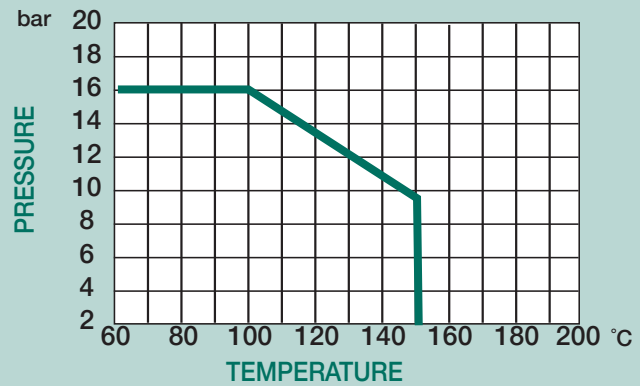

DN	15	22	28	35	42	54
B	42.5	46	53	61	62.5	70
C	111	130	142	156	172	208
D	22	25	27	27	32	37
Kgs	0.32	0.48	0.74	1.04	1.25	2.07

Technical Data

Max Pressure	16 Bar
Working Temperature	-10°C to +150°C

N.	Part Name	Materials
1	Body	Brass
2	Swing Disc	Brass
3	Plug	Brass
4	Gasket	NA1100 Black
5	Pin	Brass
6	Gasket	Vulkan
7	Screw	Brass
8	Adaptor	DZR Brass
9	O-Ring (Delta)	EPDM 70 PEROX
10	O-Ring	EPDM 70 PEROX

Dimensions in mm

This data sheet is designed as a guide and should not be regarded as wholly accurate in every detail. We reserve the right to amend the specification of any product without notice.