

Flexible Connectors

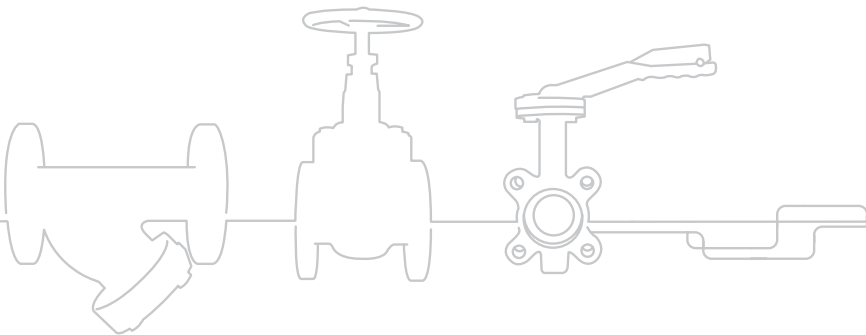

Product Information

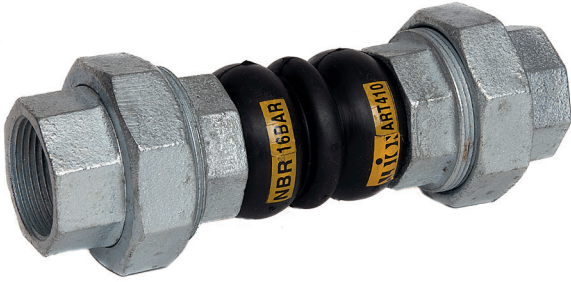



PN16 Screwed Flexible Connector

Features

- Available in Screwed BSP Taper BS21 (ISO 7/1) or NPT (ANSI B1.20.1)
- EPDM/NBR Body
- Galvanised Malleable Iron Union Ends
- Nylon Cord Fabric with Steel Reinforcement

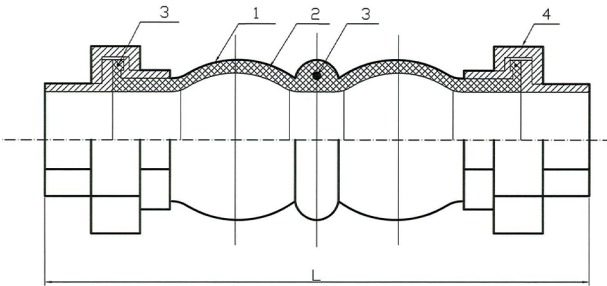

Pressure / Temperature

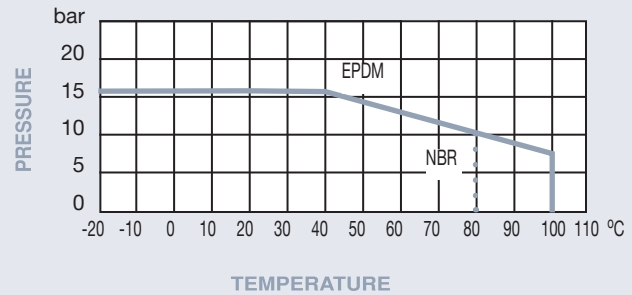

HD - Horizontal Displacement

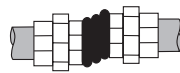

DA - Deflection Angular



Ext - Extension

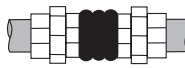

Comp - Compression

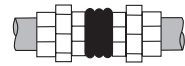

DN	1/2"	3/4"	1"	1 1/4"	1 1/2"	2"	2 1/2"	3"
L	200	200	200	200	200	200	245	245
HD	22	22	22	22	22	22	22	22
DA	45°	45°	45°	45°	45°	45°	45°	45°
Ext	5.6	5.6	5.6	5.6	5.6	5.6	5.7	5.8
Comp	22	22	22	22	22	22	22	22
Kgs	0.70	0.90	1.15	1.40	1.65	2.25	3.25	4.20

Technical Data

Max Pressure	16 Bar
Working Temperature	-20°C to +100°C EPDM -20°C to +80°C NBR

N.	Part Name	Materials 400	Materials 410
1	Body	EPDM	NBR
2	Reinforcement	Nylon Cord Wire	Nylon Cord Wire
3	Pressure Ring	Steel Wire	Steel Wire
4	Union End	Malleable Iron	Malleable Iron

Dimensions in mm

This data sheet is designed as a guide and should not be regarded as wholly accurate in every detail. We reserve the right to amend the specification of any product without notice.

PN16 Flanged Flexible Connector

Features

- Flanged PN16 BS4504
- EPDM/NBR Body
- Zinc Plated Carbon Steel Flanges
- Nylon Cord Fabric with Steel Reinforcement

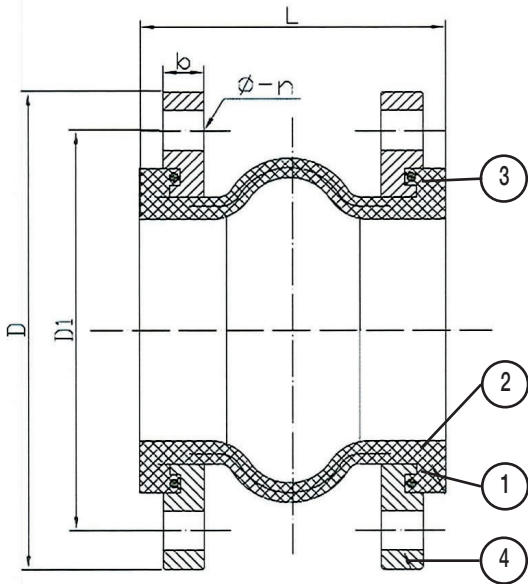
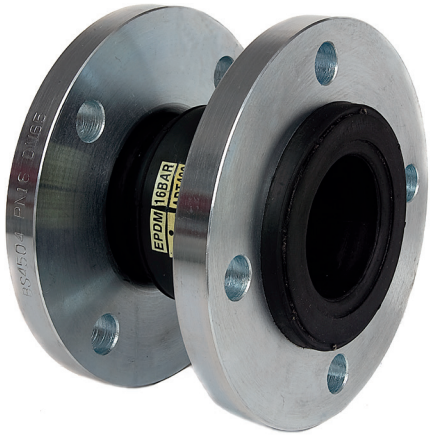

HD - Horizontal Displacement

DA - Deflection Angular

Ext - Extension

Comp - Compression

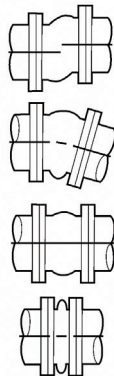

Pressure / Temperature

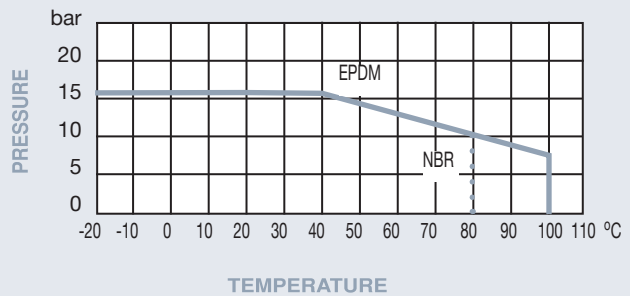

DN	1 1/4"	1 1/2"	2"	2 1/2"	3"	4"	5"	6"	8"	10"	12"	14"	16"	18"	20"	24"
D	140	150	165	185	200	220	250	285	340	405	460	520	580	640	715	840
D1	100	110	125	145	160	180	210	240	295	355	410	470	525	585	650	770
b	16	16	18	18	20	20	22	22	24	26	28	30	32	34	34	36
L	130	130	130	130	130	130	130	130	130	130	130	255	255	255	255	260
Ø-n	18-4	18-4	18-4	18-4	18-8	18-8	18-8	22-8	22-12	26-12	26-12	26-16	30-16	30-16	33-20	36-20
HD	12	12	12	12	12	12	12	12	12	12	12	12	25	25	25	25
DA	15°	15°	15°	15°	15°	15°	15°	15°	15°	15°	15°	15°	8°	8°	8°	8°
Ext	8	8	8	8	8	8	8	8	8	8	8	14	14	14	14	14
Comp	15	15	15	15	15	15	15	15	15	15	15	30	30	30	30	30
Kgs	3.2	3.7	5	6.1	7	8.5	11.5	14.4	20	26	32	41.6	56.8	70.3	82.8	99.4

Technical Data

Max Pressure	16 Bar
Working Temperature	-20°C to +100°C EPDM -20°C to +80°C NBR

N.	Part Name	Materials 420	Materials 430
1	Body	EPDM	NBR
2	Reinforcement	Nylon Cord Wire	Nylon Cord Wire
3	Pressure Ring	Steel Wire	Steel Wire
4	Flange	Carbon Steel	Carbon Steel

Dimensions in mm

This data sheet is designed as a guide and should not be regarded as wholly accurate in every detail. We reserve the right to amend the specification of any product without notice.

ANSI 150 Flanged Flexible Connector

Features

- Flanged ANSI 150 (B1.20.1)
- EPDM/NBR Body
- Zinc Plated Carbon Steel Flanges
- Nylon Cord Fabric with Steel Reinforcement

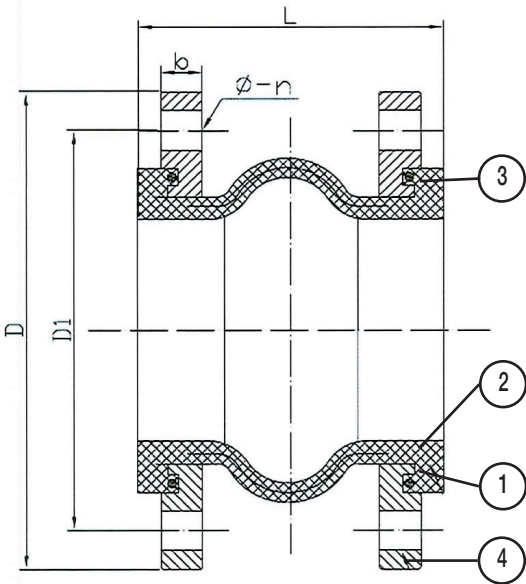

HD - Horizontal Displacement

DA - Deflection Angular

Ext - Extension

Comp - Compression

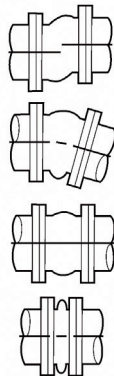

Pressure / Temperature

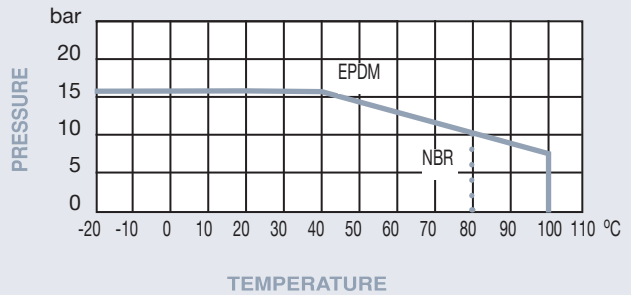

DN	1 1/4"	1 1/2"	2"	2 1/2"	3"	4"	5"	6"	8"	10"	12"	14"	16"	18"	20"	24"
D	117	127	152	178	191	229	254	279	343	406	483	533	597	635	699	813
D1	89	99	121	140	152	191	216	241	299	362	432	476	640	578	635	749
b	16	16	18	18	20	20	22	22	24	26	28	30	32	34	34	36
L	130	130	130	130	130	130	130	130	130	130	130	255	255	255	255	260
Ø-n	15.7 -4	15.7 -4	19.1 -4	19.1 -4	19.1 -4	19.1 -8	22.4 -8	22.4 -8	22.4 -8	25.4 -12	25.4 -12	28.4 -12	28.4 -16	31.75 -16	31.75 -20	35.1 -20
HD	12	12	12	12	12	12	12	12	12	12	12	25	25	25	25	25
DA	15°	15°	15°	15°	15°	15°	15°	15°	15°	15°	15°	8°	8°	8°	8°	8°
Ext	8	8	8	8	8	8	8	8	8	8	8	14	14	14	14	14
Comp	15	15	15	15	15	15	15	15	15	15	15	30	30	30	30	30
Kgs	3.2	3.7	5	6.1	7	8.5	11.5	14.4	20	26	32	41.6	56.8	70.3	82.8	99.4

Technical Data

Max Pressure	16 Bar
Working Temperature	-20°C to +100°C EPDM -20°C to +80°C NBR

N.	Part Name	Materials 420	Materials 430
1	Body	EPDM	NBR
2	Reinforcement	Nylon Cord Wire	Nylon Cord Wire
3	Pressure Ring	Steel Wire	Steel Wire
4	Flange	Carbon Steel	Carbon Steel

Dimensions in mm

This data sheet is designed as a guide and should not be regarded as wholly accurate in every detail. We reserve the right to amend the specification of any product without notice.

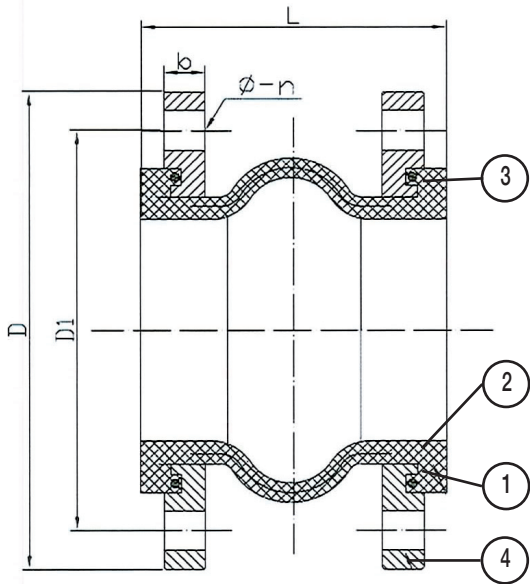

PN25 Flanged Flexible Connector

Features

- Flanged PN25
- EPDM/NBR Body
- Zinc Plated Carbon Steel Flanges
- Nylon Cord Fabric with Steel Reinforcement

Pressure / Temperature

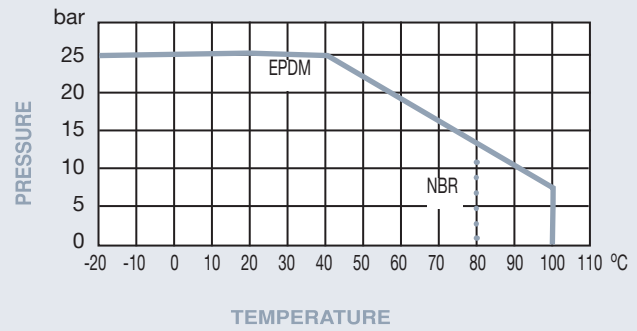

DN	1 1/4"	1 1/2"	2"	2 1/2"	3"	4"	5"	6"	8"	10"	12"
D	140	150	165	185	200	235	270	300	360	425	485
D1	100	110	125	145	160	190	220	250	310	370	430
b	16	16	18	18	20	20	22	24	26	28	30
L	130	130	130	130	130	130	130	130	130	130	130
Ø-n	18-4	18-4	18-4	18-8	18-8	22-8	26-8	26-8	26-12	30-12	30-16
HD	12	12	12	12	12	12	12	12	12	12	12
DA	15°	15°	15°	15°	15°	15°	15°	15°	15°	15°	15°
Ext	8	8	8	8	8	8	8	8	8	8	8
Comp	15	15	15	15	15	15	15	15	15	15	15
Kgs	3.4	3.9	5.3	6.1	7.6	10.4	14.3	18.5	26.8	38.1	46.1

HD - Horizontal Displacement

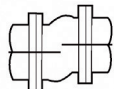

DA - Deflection Angular

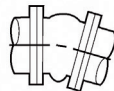

Ext - Extension

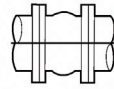

Comp - Compression

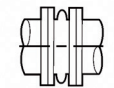

Technical Data

Max Pressure	25 Bar
Working Temperature	-20°C to +100°C EPDM -20°C to +80°C NBR

N.	Part Name	Materials 420	Materials 430
1	Body	EPDM	NBR
2	Flange	Carbon Steel	Carbon Steel
3	Pressure Ring	Steel Wire	Steel Wire
4	Flange	Carbon Steel	Carbon Steel

Dimensions in mm

This data sheet is designed as a guide and should not be regarded as wholly accurate in every detail. We reserve the right to amend the specification of any product without notice.



PN10 Flanged Flexible Connector

Features

- Flanged PN10 BS4504
- EPDM/NBR Body
- Zinc Plated Carbon Steel Flanges
- Nylon Cord Fabric with Steel Reinforcement

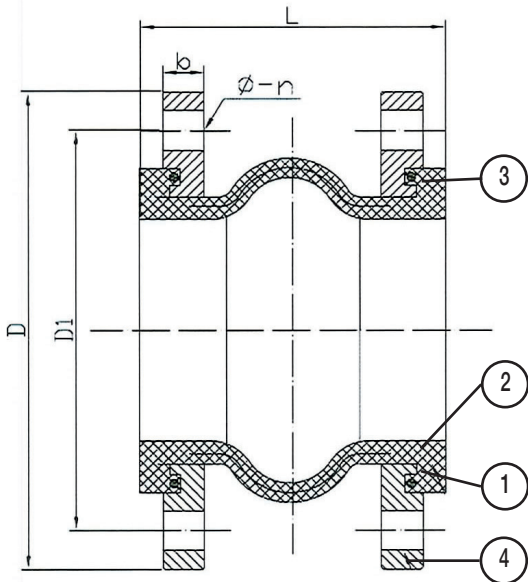

Pressure / Temperature

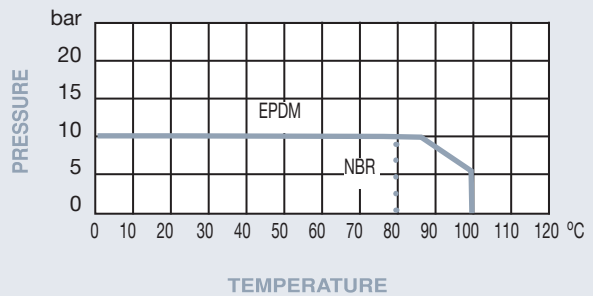

HD - Horizontal Displacement

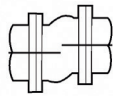

DA - Deflection Angular

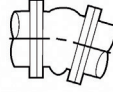

Ext - Extension

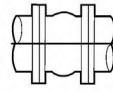

Comp - Compression

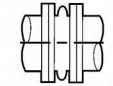

DN	1 1/4"	1 1/2"	2"	2 1/2"	3"	4"	5"	6"	8"	10"	12"
D	140	150	165	185	200	220	250	285	340	395	445
D1	100	110	125	145	160	180	210	240	295	350	400
b	16	16	18	18	20	20	22	22	24	26	26
L	130	130	130	130	130	130	130	130	130	130	130
Ø-n	18-4	18-4	18-4	18-4	18-8	18-8	18-8	22-8	22-8	22-12	22-12
HD	12	12	12	12	12	12	12	12	12	12	12
DA	15°	15°	15°	15°	15°	15°	15°	15°	15°	15°	15°
Ext	8	8	8	8	8	8	8	8	8	8	8
Comp	15	15	15	15	15	15	15	15	15	15	15
Kgs	1.94	2.14	2.67	3.14	3.57	4.10	5.56	6.70	8.90	9.96	15.93

Technical Data

Max Pressure	10 Bar
Working Temperature	-20°C to +100°C EPDM -20°C to +80°C NBR

N.	Part Name	Materials 425	Materials 435
1	Body	EPDM	NBR
2	Reinforcement	Nylon Cord Wire	Nylon Cord Wire
3	Pressure Ring	Steel Wire	Steel Wire
4	Flange	Carbon Steel	Carbon Steel

Dimensions in mm

This data sheet is designed as a guide and should not be regarded as wholly accurate in every detail. We reserve the right to amend the specification of any product without notice.



PN6 Flanged Flexible Connector

Features

- Flanged PN6 BS4504
- EPDM Body
- Zinc Plated Carbon Steel Flanges
- Nylon Cord Fabric with Steel Reinforcement

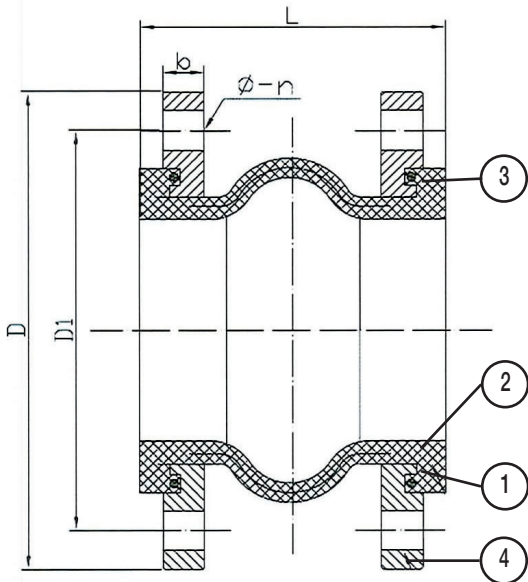

Pressure / Temperature

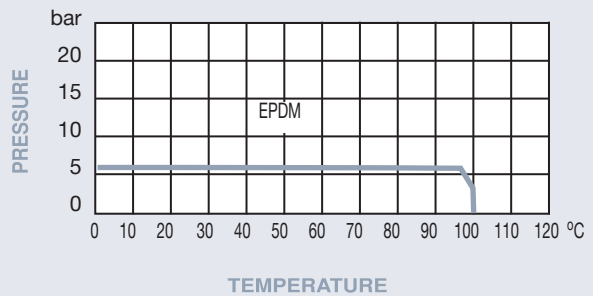

HD - Horizontal Displacement

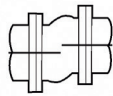

DA - Deflection Angular

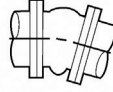

Ext - Extension

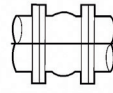

Comp - Compression

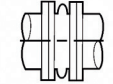

DN	1 1/4"	1 1/2"	2"	2 1/2"	3"	4"	5"	6"	8"	10"	12"
D	140	150	165	185	200	220	250	285	340	405	460
D1	90	100	110	130	150	170	200	225	280	335	395
b	16	16	18	18	20	20	22	22	24	26	28
L	130	130	130	130	130	130	130	130	130	130	130
Ø-n	14-4	14-4	14-4	14-4	18-4	18-4	18-8	18-8	18-8	18-12	22-12
HD	12	12	12	12	12	12	12	12	12	12	12
DA	15°	15°	15°	15°	15°	15°	15°	15°	15°	15°	15°
Ext	8	8	8	8	8	8	8	8	8	8	8
Comp	15	15	15	15	15	15	15	15	15	15	15
Kgs	1.94	2.14	2.67	3.14	3.57	4.10	5.56	6.70	8.90	9.96	15.93

Technical Data

Max Pressure 6 Bar

Working Temperature -20°C to +100°C EPDM

N.	Part Name	Materials 427
1	Body	EPDM
2	Reinforcement	Nylon Cord Wire
3	Pressure Ring	Steel Wire
4	Flange	Carbon Steel

Dimensions in mm

This data sheet is designed as a guide and should not be regarded as wholly accurate in every detail. We reserve the right to amend the specification of any product without notice.



PN16 Tied Flanged Flexible Connector

Features

- Flanged PN16 BS4504
- EPDM/NBR Body
- Zinc Plated Carbon Steel Oval Flanges
- Nylon Cord Fabric with Steel Reinforcement

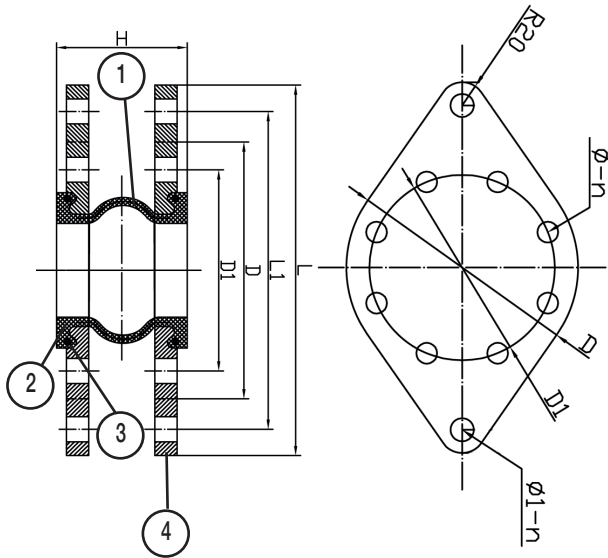

HD - Horizontal Displacement

DA - Deflection Angular

Ext - Extension

Comp - Compression

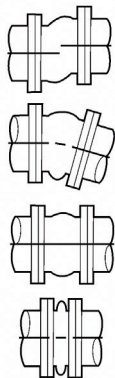

Pressure / Temperature

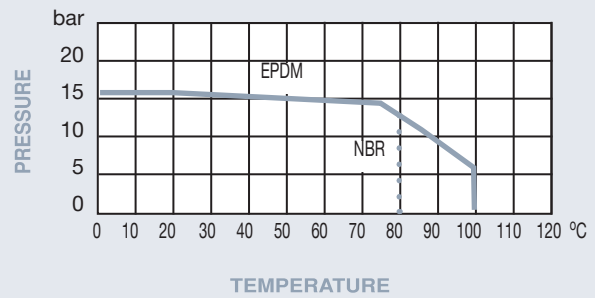

DN	32	40	50	65	80	100	125	150	200	250	300
L	222	232	247	267	286	306	336	371	440	505	560
L1	184	194	209	229	246	266	296	331	393	458	513
D	140	150	165	185	200	220	250	285	340	405	460
D1	100	110	125	145	160	180	210	240	295	355	410
H	130	130	130	130	130	130	130	130	130	130	130
Ø-n	18-4	18-4	18-4	18-4	18-8	18-8	18-8	22-8	22-12	26-12	26-12
Ø1-n	18-2	18-2	18-2	18-2	20-2	20-2	20-2	20-2	27-2	27-2	27-2
HD	12	12	12	12	12	12	12	12	12	12	12
DA	15°	15°	15°	15°	15°	15°	15°	15°	15°	15°	15°
Ext	8	8	8	8	8	8	8	8	8	8	8
Comp	15	15	15	15	15	15	15	15	15	15	15
Kgs	4.12	4.76	6.47	8.1	9.6	10.8	14.8	17.1	22.8	34.0	41.9

Technical Data

Max Pressure	16 Bar
Working Temperature	-20°C to +100°C EPDM -20°C to +80°C NBR

N.	Part Name	Materials 450	Materials 460
1	Body	EPDM	NBR
2	Reinforcement	Nylon Cord Wire	Nylon Cord Wire
3	Pressure Ring	Steel Wire	Steel Wire
4	Flange	Carbon Steel	Carbon Steel

Dimensions in mm

This data sheet is designed as a guide and should not be regarded as wholly accurate in every detail. We reserve the right to amend the specification of any product without notice.



PN10 Tied Flanged Flexible Connector

Features

- Flanged PN10 BS4504
- EPDM/NBR Body
- Zinc Plated Carbon Steel Oval Flanges
- Nylon Cord Fabric with Steel Reinforcement

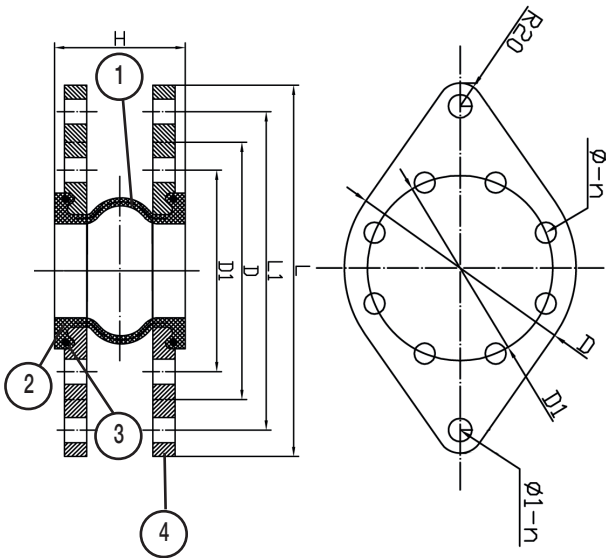

Pressure / Temperature

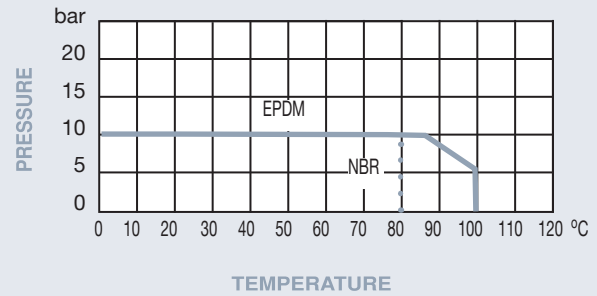

HD - Horizontal Displacement

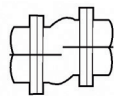

DA - Deflection Angular

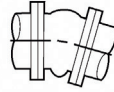

Ext - Extension

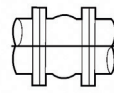

Comp - Compression

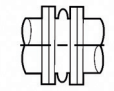

DN	32	40	50	65	80	100	125	150	200	250	300
L	222	232	247	267	286	306	336	371	432	495	545
L1	184	194	209	229	246	266	296	331	398	448	498
D	140	150	165	185	200	220	250	285	340	395	445
D1	100	110	125	145	160	180	210	240	295	350	400
H	130	130	130	130	130	130	130	130	130	130	130
Ø1-n	18-4	18-4	18-4	18-4	18-8	18-8	18-8	22-8	22-8	22-12	22-12
Ø1-n	18-2	18-2	18-2	18-2	20-2	20-2	20-2	20-2	27-2	27-2	27-2
HD	12	12	12	12	12	12	12	12	12	12	12
DA	15°	15°	15°	15°	15°	15°	15°	15°	15°	15°	15°
Ext	8	8	8	8	8	8	8	8	8	8	8
Comp	15	15	15	15	15	15	15	15	15	15	15
Kgs	4.12	4.76	6.47	8.1	9.6	10.8	14.8	17.1	22.8	34.0	41.9

Technical Data

Max Pressure	10 Bar
Working Temperature	-20°C to +100°C EPDM -20°C to +80°C NBR

N.	Part Name	Materials 455	Materials 465
1	Body	EPDM	NBR
2	Reinforcement	Nylon Cord Wire	Nylon Cord Wire
3	Pressure Ring	Steel Wire	Steel Wire
4	Flange	Carbon Steel	Carbon Steel

Dimensions in mm

This data sheet is designed as a guide and should not be regarded as wholly accurate in every detail. We reserve the right to amend the specification of any product without notice.

Selection

Prior to installation check you have selected the correct flexible connector for the application, pressure, temperature and media requirements.

Inspection

Before installing flexible connectors they should be checked for any damage internally and externally paying particular attention to the mating face. Make sure the sealing face is clean and free of debris as this will prevent sealing with the mating flange.

Installation

Flexible connectors should be installed at their natural length. If gaps are being left in the pipework for retro fitting make sure this gap conforms to the exact natural length of the connector. Pipework should be aligned before installation the connector is not designed to compensate for poorly aligned pipework.

Please consult datasheet for allowable movement.

The correct mating flange should always be selected and the sealing face checked for debris and any sharp edges as this could result in damage to the rubber.

If faces of mating flanges have a different diameter a sealing gasket should be used to avoid damage to the rubber face.

Flange bolts must be fitted with the bolt head nearest the connector to avoid damage to the rubber. Bolts must be tightened in a gradual manner tightening opposite bolts in turn. Do not over tighten as this will result in leakage. It is prudent to check tighten the bolts after seven days.

Avoid installation in direct sunlight and dry hot air as this can reduce the lifetime of the rubber.

The presence of any solid debris, dirt or grit in the media can lead to abrasion of the interior rubber and a much reduced product service life. Strainers should always be fitted to remove such debris from the media.

Anchoring

It is essential that flexible connectors are anchored to protect adjacent pipework and plant. Fig 1 shows how to anchor pipework in close installation to pumps. Selection of tied rubber flexible connectors should be considered above 100mm when the pressure is greater than 2.5 bar.

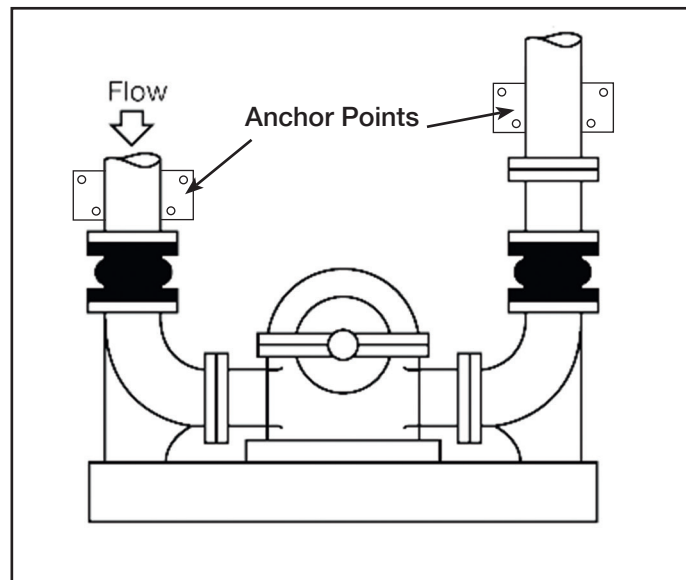

Maintenance

Many years of trouble free installation can be achieved with properly installed flexible connectors. It is essential they are used within their temperature, pressure and media limitations. Regular inspection of the rubber is advised to check for deterioration we also advise a thorough internal and external inspection after a maximum of 3 years of service and replacement should be considered if deterioration or wear is witnessed. Flange bolts checked for correct tightness at regular intervals. The rubber should never be painted as this could damage the rubber and lead to reduced performance and service life.



URS is a member of Registrar of Standards (Holdings) Ltd.

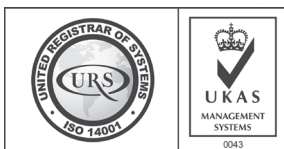

URS is a member of Registrar of Standards (Holdings) Ltd.

Distributor