

ART 135GB PN25

DN200-300 Ductile Iron

Butterfly Valve Lugged and Tapped

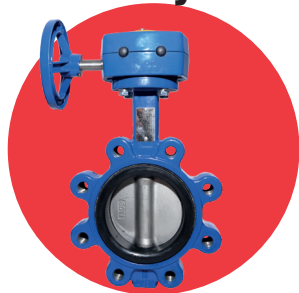

Features

- Flange mounting PN25 only
- BS5155 (BS EN 593)
- ISO 5211 direct mount
- Epoxy coat finish
- Vulcanised liner

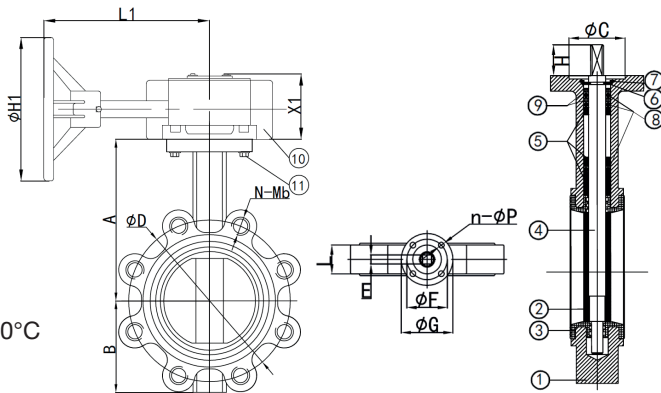

Technical data

Max pressure: 25 Bar

Working temp: -10°C to +110°C

DN	200	250	300
A	247	280	324
B	173	207	250
C	71	71	71
D	310	370	430
E	17	22	22
F	102	102	102
G	125	125	125
H	25	30	30
H1	215	215	215
L	60	68	78
L1	216	216	216
X1	71	71	71
N-Mb	12-M24	12-M27	16-M27
N-Øp	4-12	4-12	4-12
Torque	290	400	510
Kv	3842	5014	9230
Kgs	33.0	47.0	69.0

N. Part Name Materials

1	Body	Ductile Iron GGG40
2	Disc	Stainless Steel 316 (CF8M)
3	Seat	EPDM
4	Shaft	Stainless Steel 431
5	Bushing	Brass H65
6	Cotter Pin	Spring Steel 65Mn
7	Circlip	Spring Steel 65Mn
8	O-Ring	NBR
9	Ring	Nylon 6 PA6
10	Gearbox	Aluminium AL102
11	Bolt	Stainless Steel 304

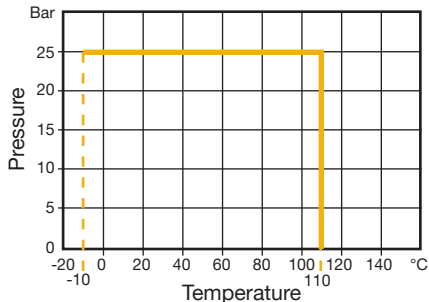

V2. Dimensions in mm

This data sheet is designed as a guide and should not be regarded as wholly accurate in every detail. We reserve the right to amend the specification of any product without notice.