



Installation & Operating Manual



ART 250 Variable Orifice Double Regulating Valve

Albion Valves (UK) Ltd
www.albionvalvesuk.com
Email: sales@albionvalvesuk.com
Tel: 01226 729900



Contents

1. Introduction
2. Technical Data
3. Valve Features
4. Valve Installation
5. Approvals Classification
6. Troubleshooting
7. Warranty

1. Introduction

- Albion Valves (UK) Ltd ART 250 is a Variable Orifice Double Regulating Valve (VODRV) used to regulate and measure the flow of media passing through it.
- The ART 250 has been classified in accordance with PED 2014/68/EU.

2. Technical Data

Valve Type	Size Range	Connection Type	Temperature Rating	Pressure Rating (Max)
ART 250 PN 16	DN 50 – DN 300	EN 1092 PN 16	-20°C – 120°C	16 bar
ART 250 PN 25	DN 50 – DN 300	EN 1092 PN 25	-20°C – 120°C	25 bar

Flow Coefficient

The flow rate can be calculated using the Kv value and a measured signal.

$$Kv = Q \cdot 36 / \sqrt{\Delta P} \quad Kvs = Q \cdot 36 / \sqrt{\Delta Ps}$$

Where Kv & Kvs = flow coefficient (m³/hr at 1 bar differential)

Q - Flow rate (l/s)

ΔP - Headloss attributable to valve (kPa)

ΔPs - Differential pressure across tappings (signal) (kPa)

Kvs Values

Size	50	65	80	100	125	150	200	250	300
Kvs	48.2	82.6	117.4	211.4	381.5	462.4	790	1135	2022

Sizing

Once the required flow rate has been calculated, the size of the Variable Orifice Double Regulating Valve can be determined based on the following:

With the valve fully open, a minimum signal at the design flow rate of 1 kPa. The maximum signal is normally less than 5 kPa but can be up to 10 kPa. For sizing the flow velocity should not exceed 3 m/s at the design flow rate.

3. Valve Features

- The ART 250 VODRV is manufactured in accordance with BS 7350.
- Test points are supplied with the ART 250 FODRV.

4. Valve Installation

- The valve should be sited to ensure ease of access.
- It is the responsibility of the installer to ensure the valve is suitable for service conditions e.g., temperature, pressure, and service media.
- Where fitted, remove flange protectors / dust caps and all other packaging material.
- Care should be taken to ensure the surface finish of the valve is protected during installation.
- The valves may be installed in horizontal or vertical pipework.
- The valve is uni-directional and should only be used for flow in the direction shown on the valve.
- Suitable gaskets / sealing material should be used during installation.
- ART 250 VODRV should be installed with a minimum of 5 pipe diameters upstream and 2 pipe diameters downstream, this is to ensure flow accuracy is maintained during the commissioning stage.
- The memory stop can be set once the valve is at the correct design flow rate. This can be done by removing the black handwheel cap and rotating the cross head screw in a clockwise direction until resistance is met.

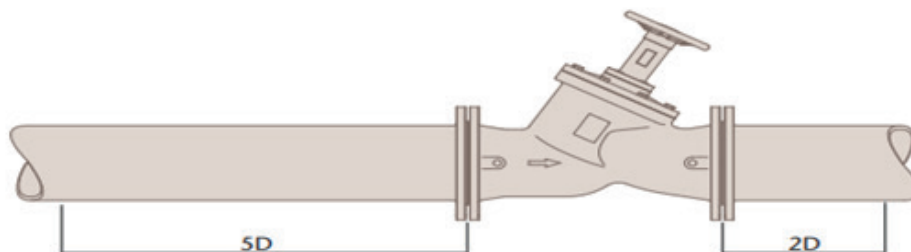

5. Approvals Classification

- The valve is classified in accordance with PED 2014/68/EU as Sound Engineering Practice (SEP).

6. Troubleshooting

- If any maintenance is to be undertaken on the valve it is the responsibility of the installer to ensure the system is adequately drained and depressurized.
- A full risk assessment should be undertaken prior to any works taking place.

7. Warranty

- For further details of Albion Valves (UK) Ltd warranty period, please refer to Albion Valves (UK) Ltd 'Conditions of Sale' available on our website.

DN50 ART 250 Variable Orifice Double Regulating Valve

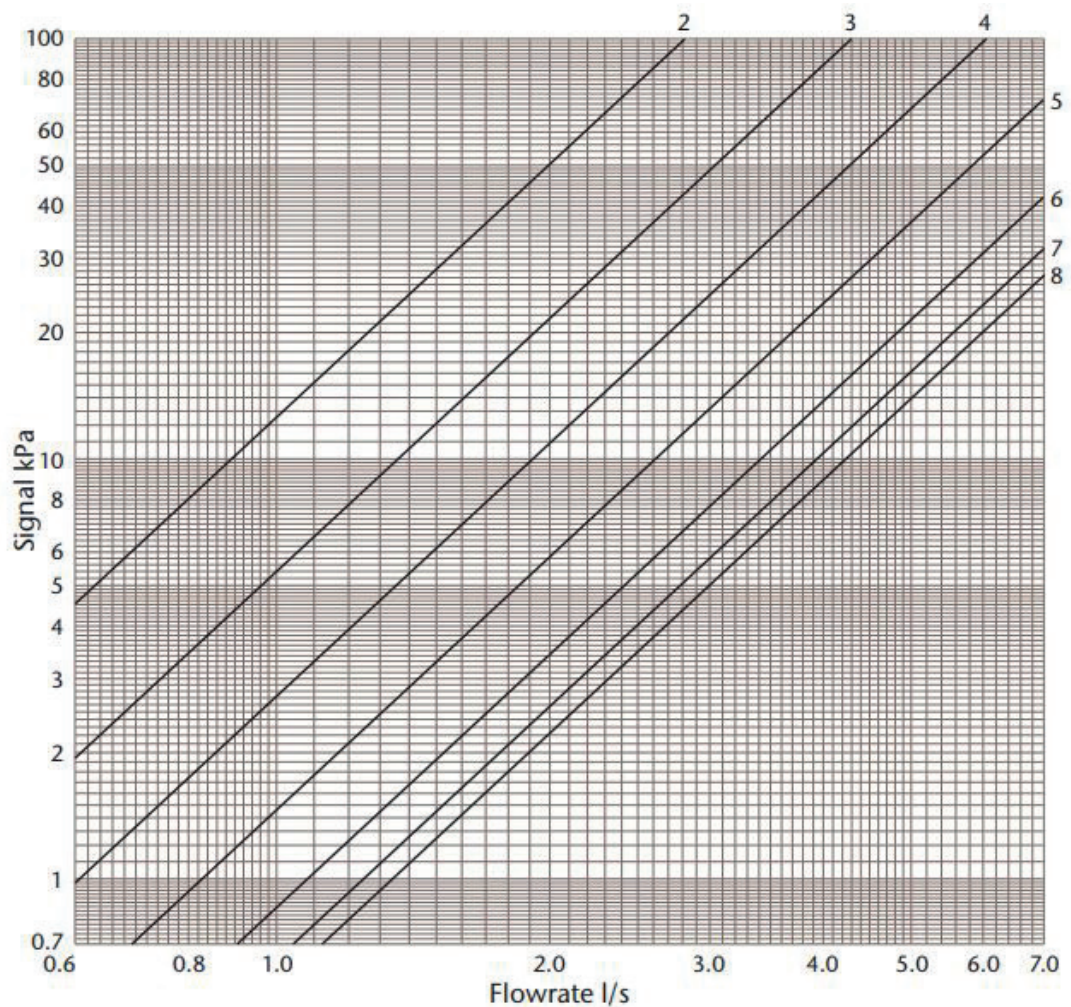

Position	2	3	4	5	6	7	8
Kvs	10.2	15.2	21.9	29.7	38.9	44.7	48.2

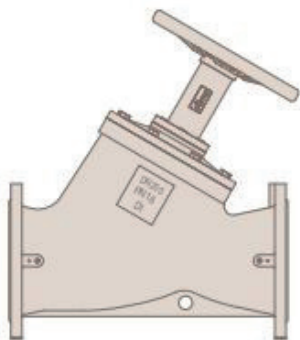

Signal / Flowrate

Chart used to determine flowrate from signal measured across orifice

$$Q = \frac{Kvs \sqrt{\Delta p}}{36}$$

Where

Q = Flowrate l/s

Δp = Signal kPa

Kvs = Signal Co-efficient

DN65 ART 250 Variable Orifice Double Regulating Valve

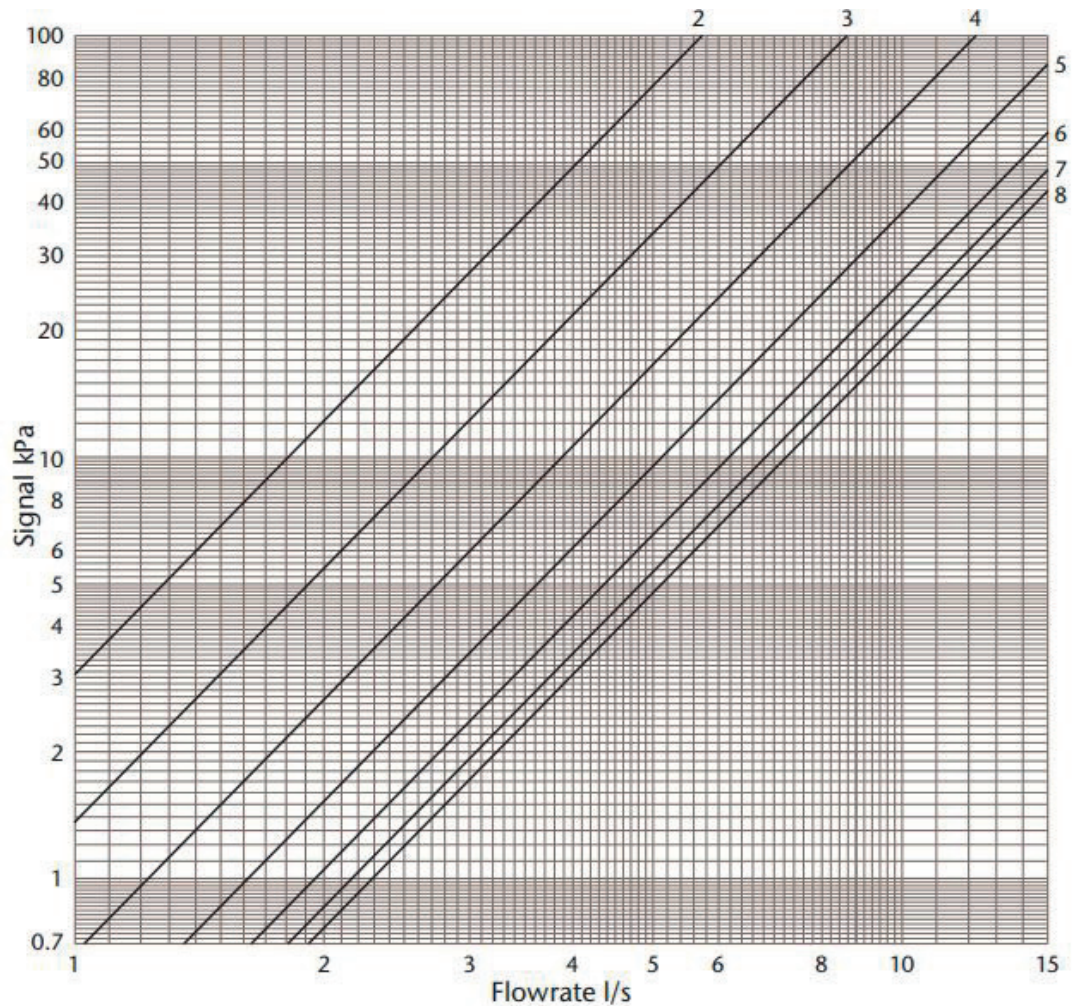

Position	2	3	4	5	6	7	8
Kvs	20.6	30.9	44.0	58.3	70.3	77.8	82.6

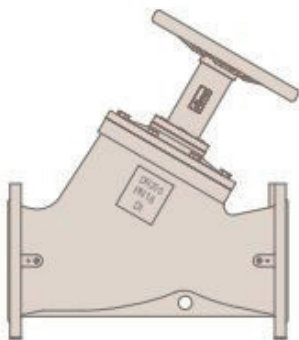

Signal / Flowrate

Chart used to determine flowrate from signal measured across orifice

$$Q = \frac{Kvs \sqrt{\Delta p}}{36}$$

Where

Q = Flowrate l/s

Δp = Signal kPa

Kvs = Signal Co-efficient

DN80 ART 250 Variable Orifice Double Regulating Valve

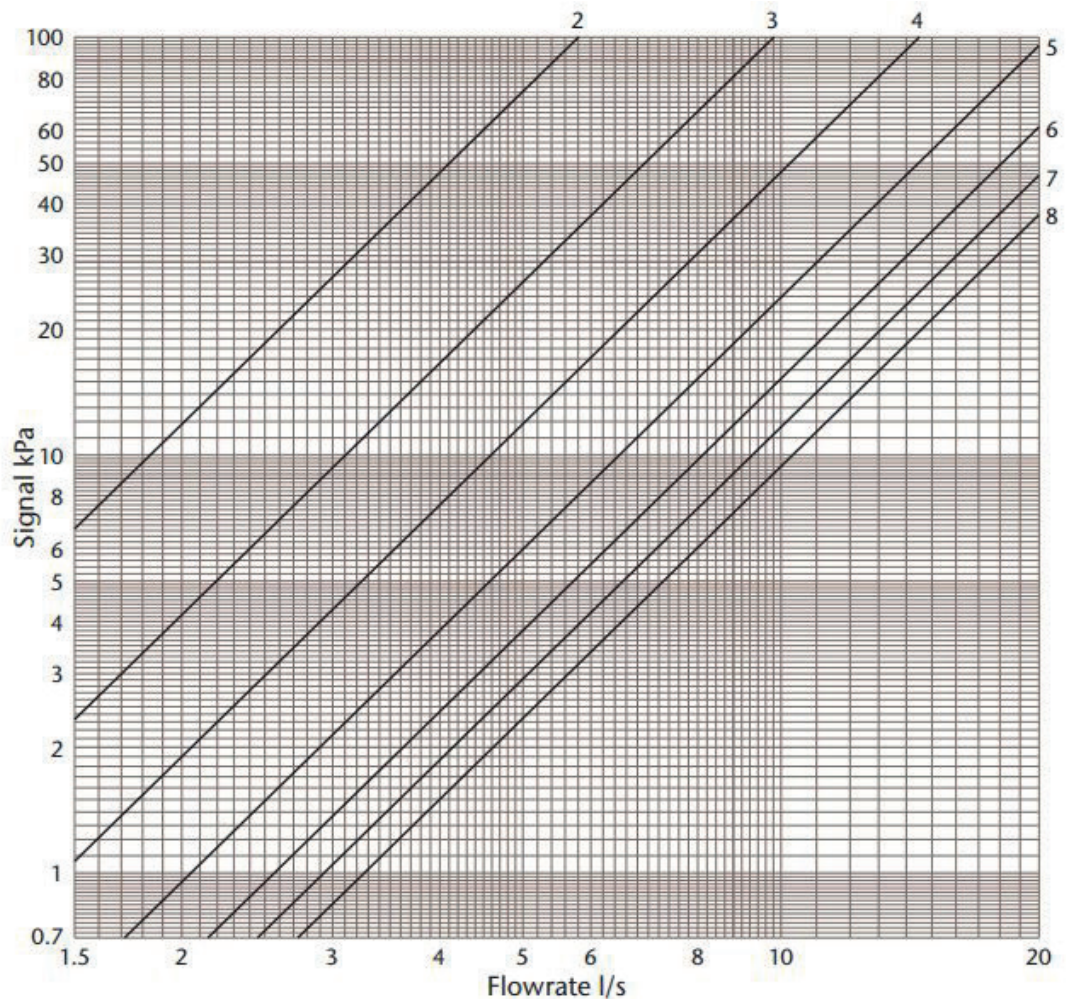

Position	2	3	4	5	6	7	8
Kvs	20.9	35.4	52.1	73.7	92.1	105.6	117.4

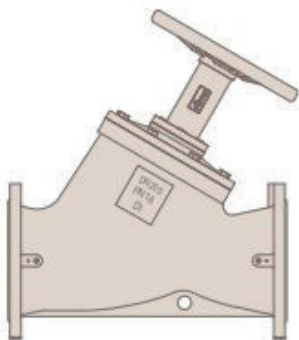

Signal / Flowrate

Chart used to determine flowrate from signal measured across orifice

$$Q = \frac{Kvs \sqrt{\Delta p}}{36}$$

Where

Q = Flowrate l/s

Δp = Signal kPa

Kvs = Signal Co-efficient

DN100 ART 250 Variable Orifice Double Regulating Valve

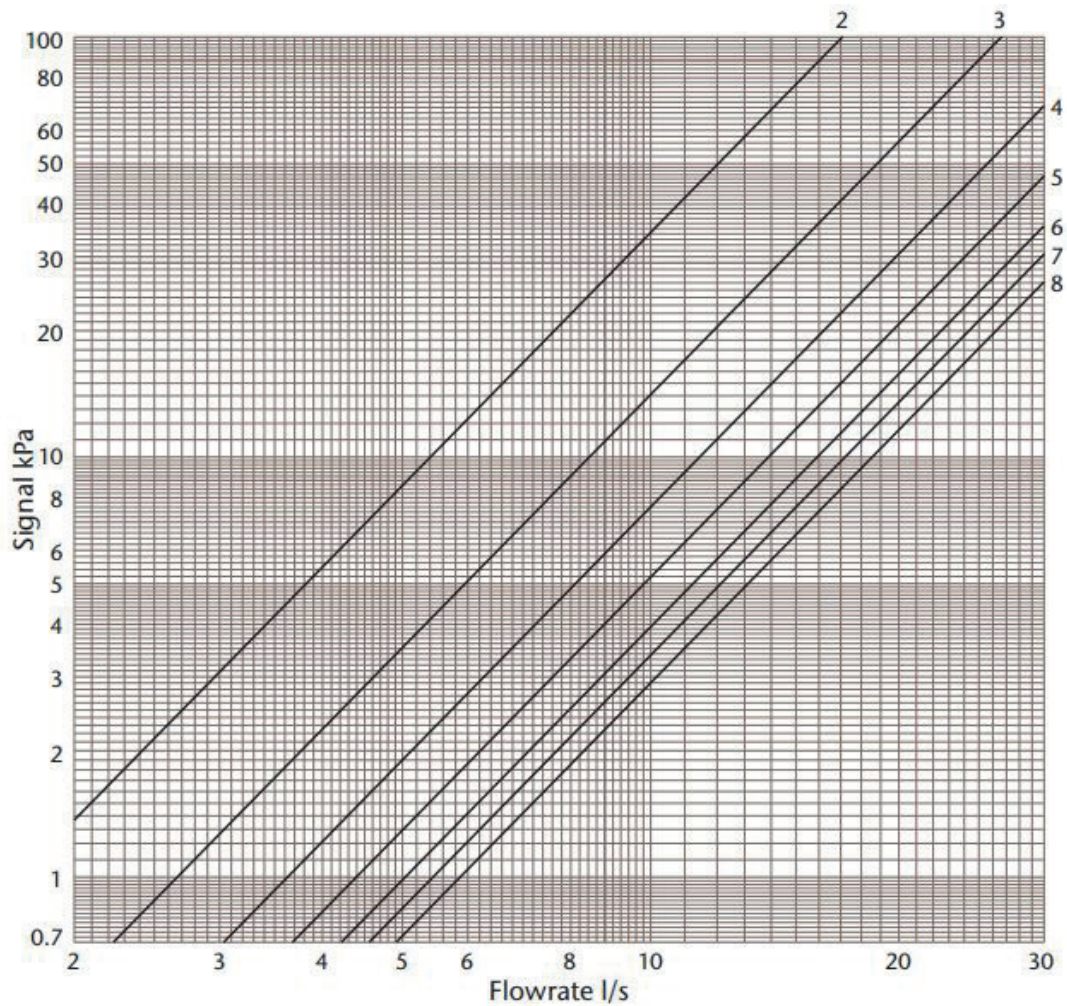

Position	2	3	4	5	6	7	8
Kvs	61.5	95.7	130.4	158.1	181.3	195.6	211.4

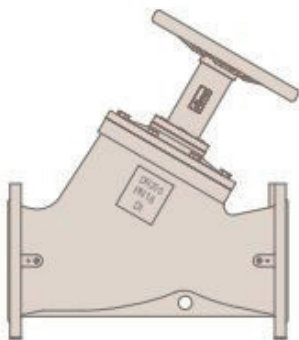

Signal / Flowrate

Chart used to determine flowrate from signal measured across orifice

$$Q = \frac{Kvs \sqrt{\Delta p}}{36}$$

Where

Q = Flowrate l/s

Δp = Signal kPa

Kvs = Signal Co-efficient

DN125 ART 250 Variable Orifice Double Regulating Valve

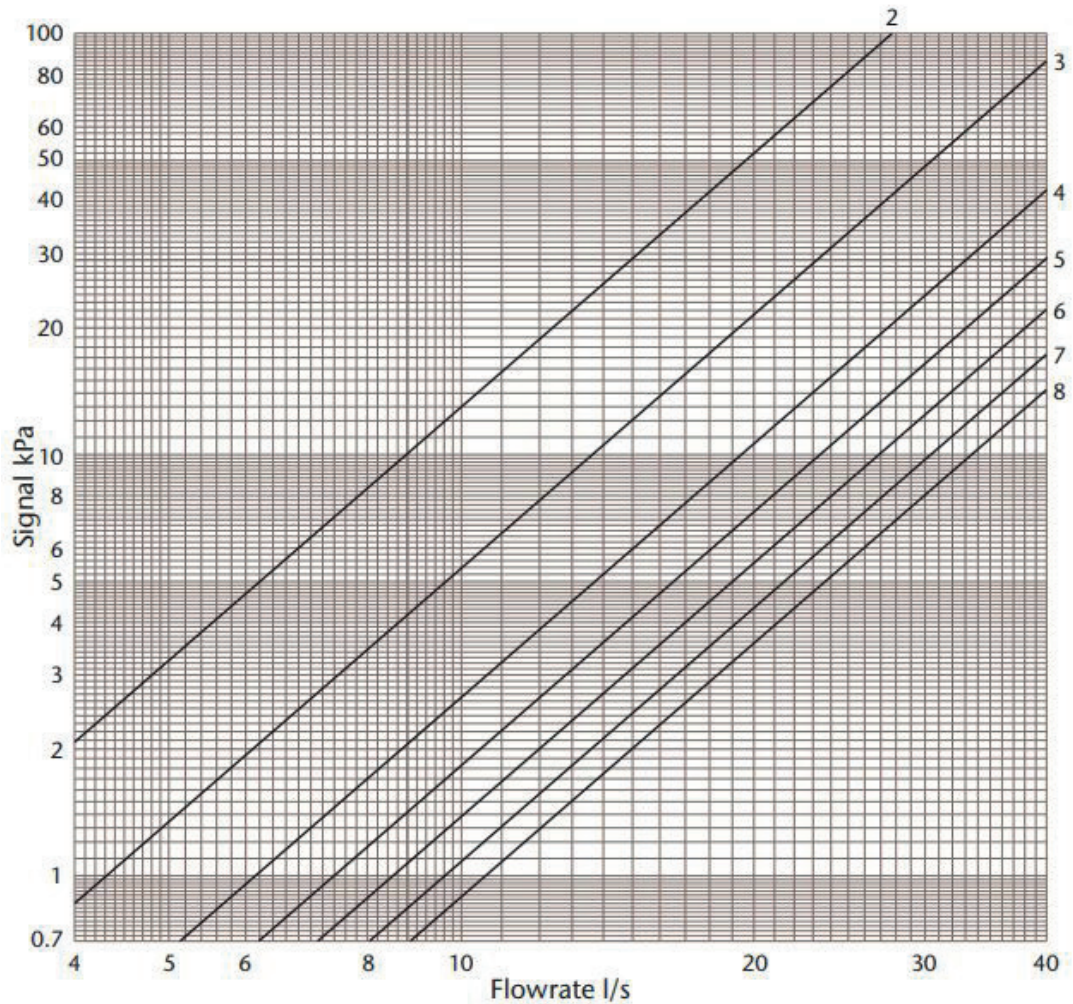

Position	2	3	4	5	6	7	8
Kvs	99.9	155.3	221.0	266.5	305.9	346.6	381.5

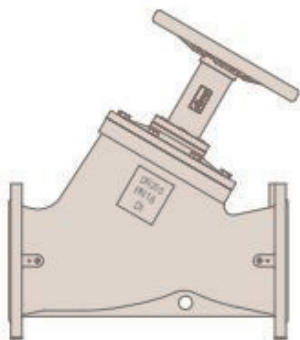

Signal / Flowrate

Chart used to determine flowrate from signal measured across orifice

$$Q = \frac{Kvs \sqrt{\Delta p}}{36}$$

Where

Q = Flowrate l/s

Δp = Signal kPa

Kvs = Signal Co-efficient

DN150 ART 250 Variable Orifice Double Regulating Valve

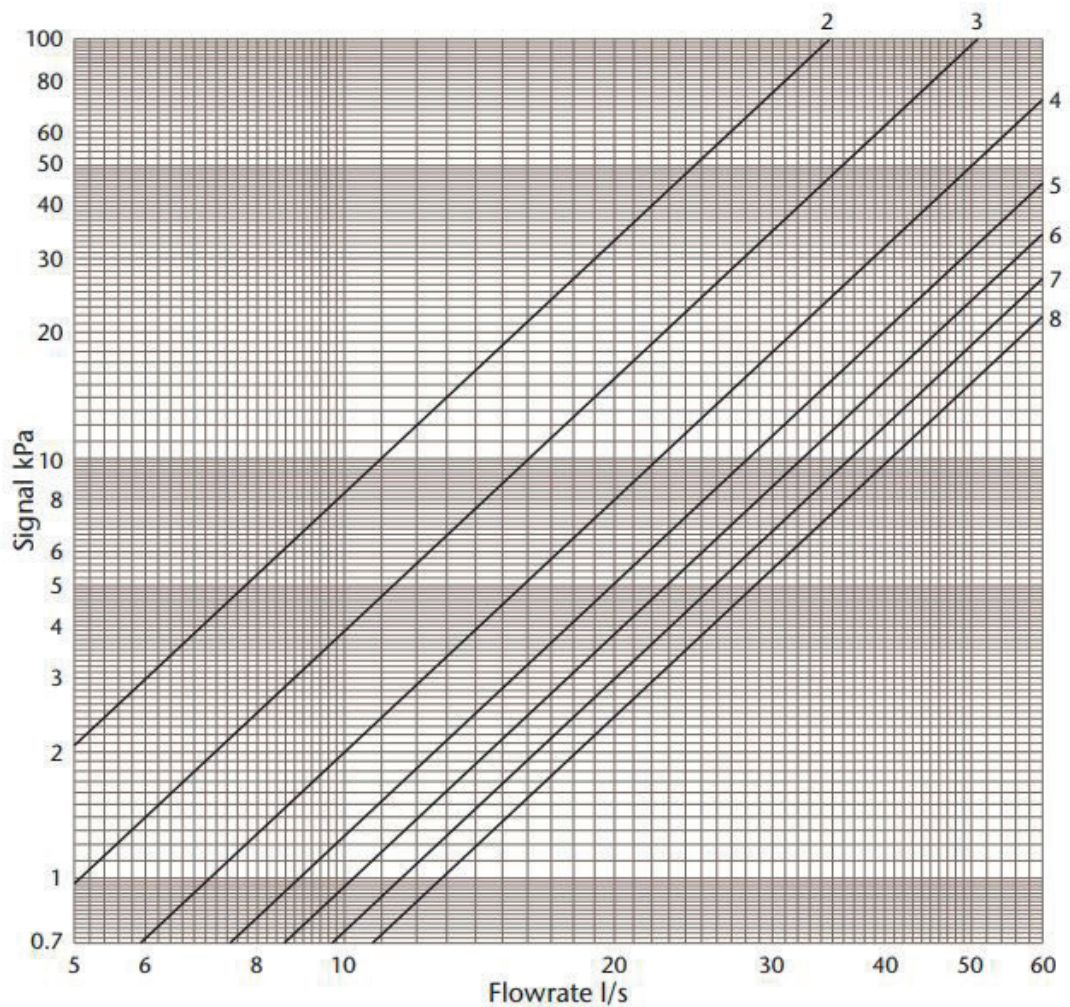

Position	2	3	4	5	6	7	8
Kvs	125.1	183.3	254.9	320.5	369.2	418.0	462.4

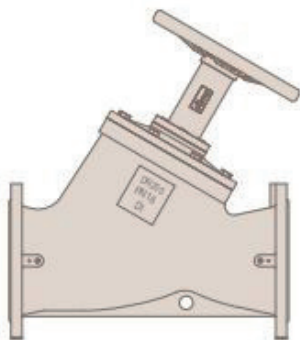

Signal / Flowrate

Chart used to determine flowrate from signal measured across orifice

$$Q = \frac{Kvs \sqrt{\Delta p}}{36}$$

Where

Q = Flowrate l/s

Δp = Signal kPa

Kvs = Signal Co-efficient

DN200 ART 250 Variable Orifice Double Regulating Valve

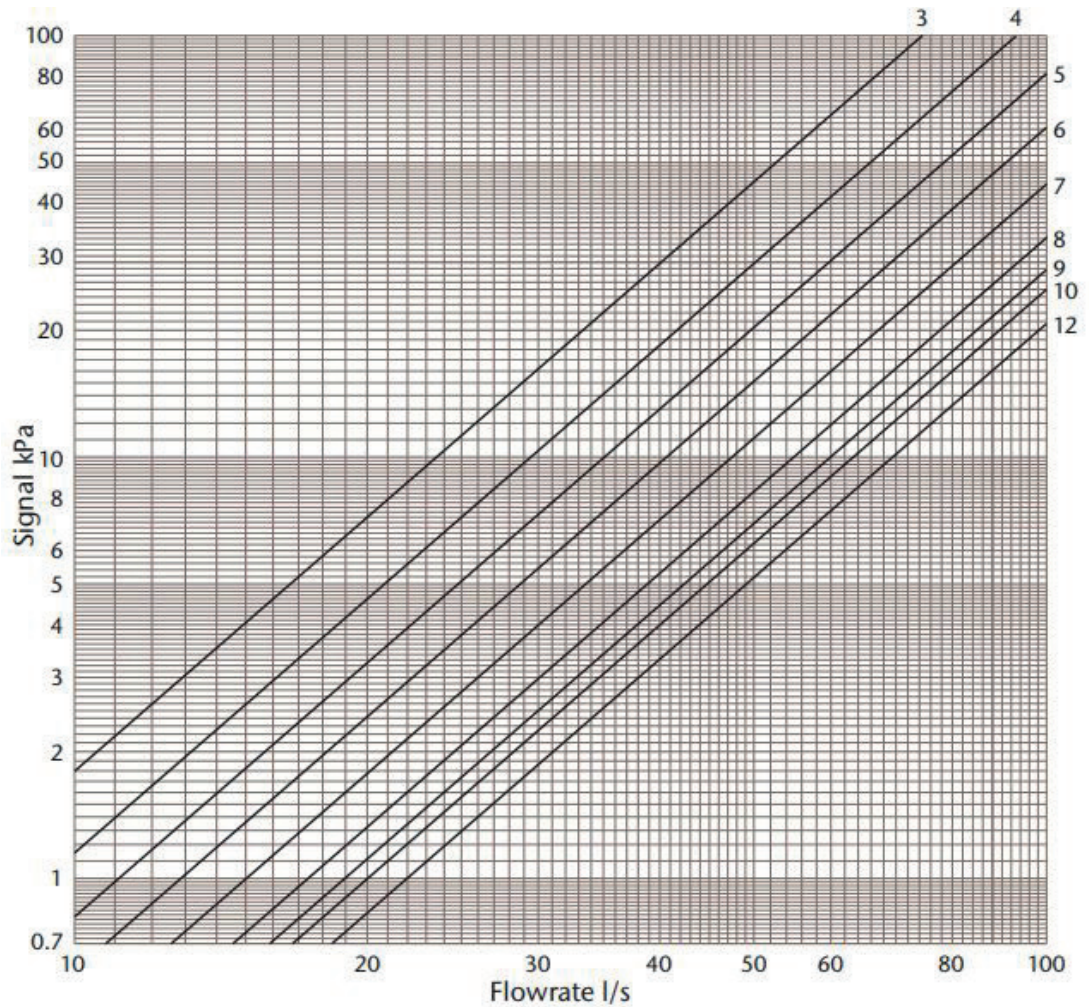

Position	3	4	5	6	7	8	9	10	12
Kvs	268.1	335.3	399.2	463	540	625	683	720	790

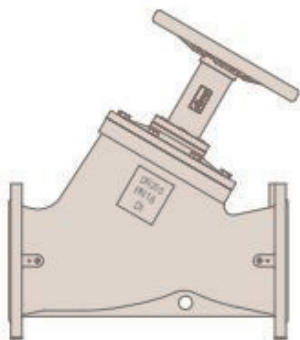

Signal / Flowrate

Chart used to determine flowrate from signal measured across orifice

$$Q = \frac{Kvs \sqrt{\Delta p}}{36}$$

Where

Q = Flowrate l/s

Δp = Signal kPa

Kvs = Signal Co-efficient

DN250 ART 250 Variable Orifice Double Regulating Valve

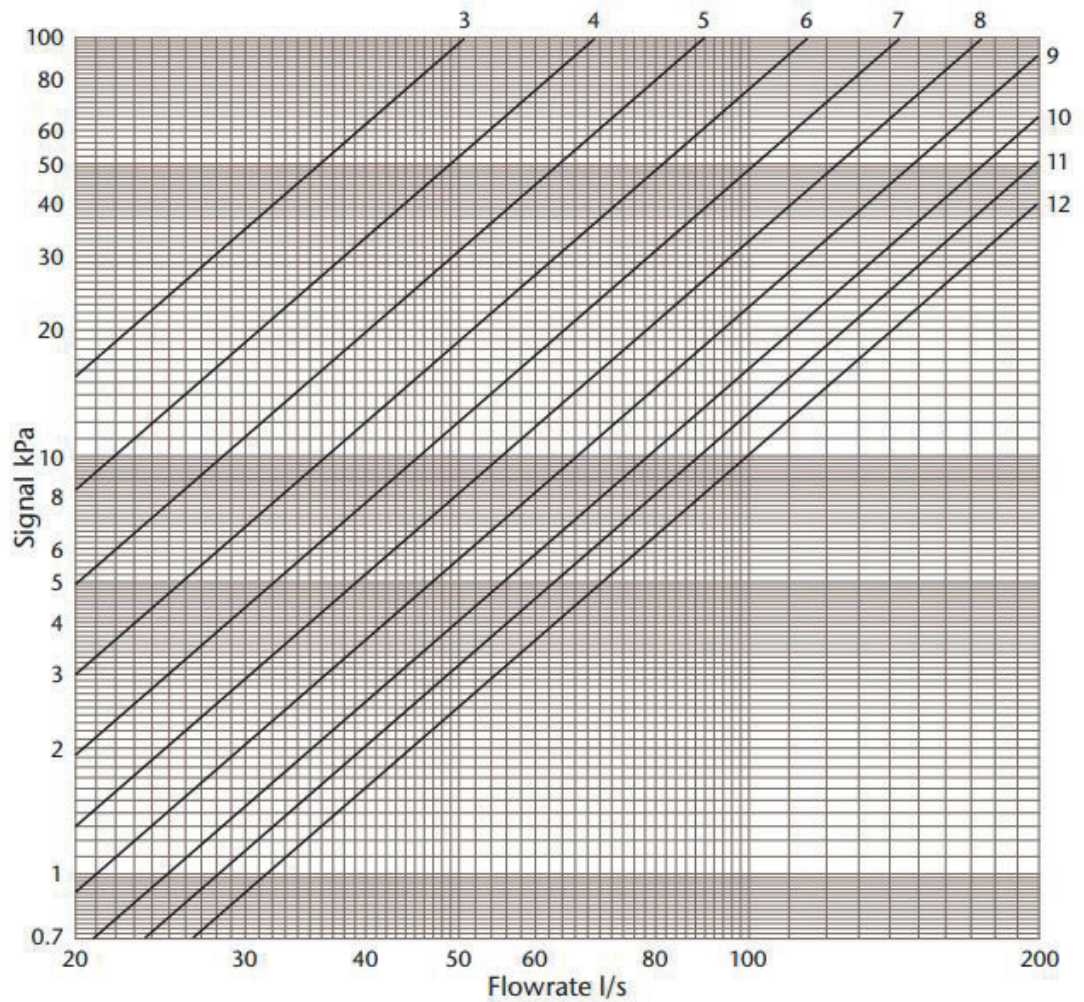

Position	3	4	5	6	7	8	9	10	11	12
Kvs	183	250	324	415	518	630	756	894	1013	1135

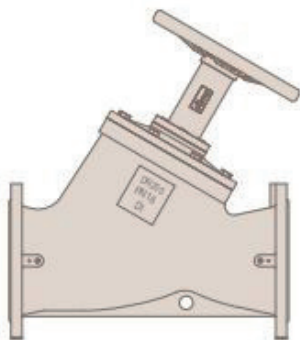

Signal / Flowrate

Chart used to determine flowrate from signal measured across orifice

$$Q = \frac{Kvs \sqrt{\Delta p}}{36}$$

Where

Q = Flowrate l/s

Δp = Signal kPa

Kvs = Signal Co-efficient

DN300 ART 250 Variable Orifice Double Regulating Valve

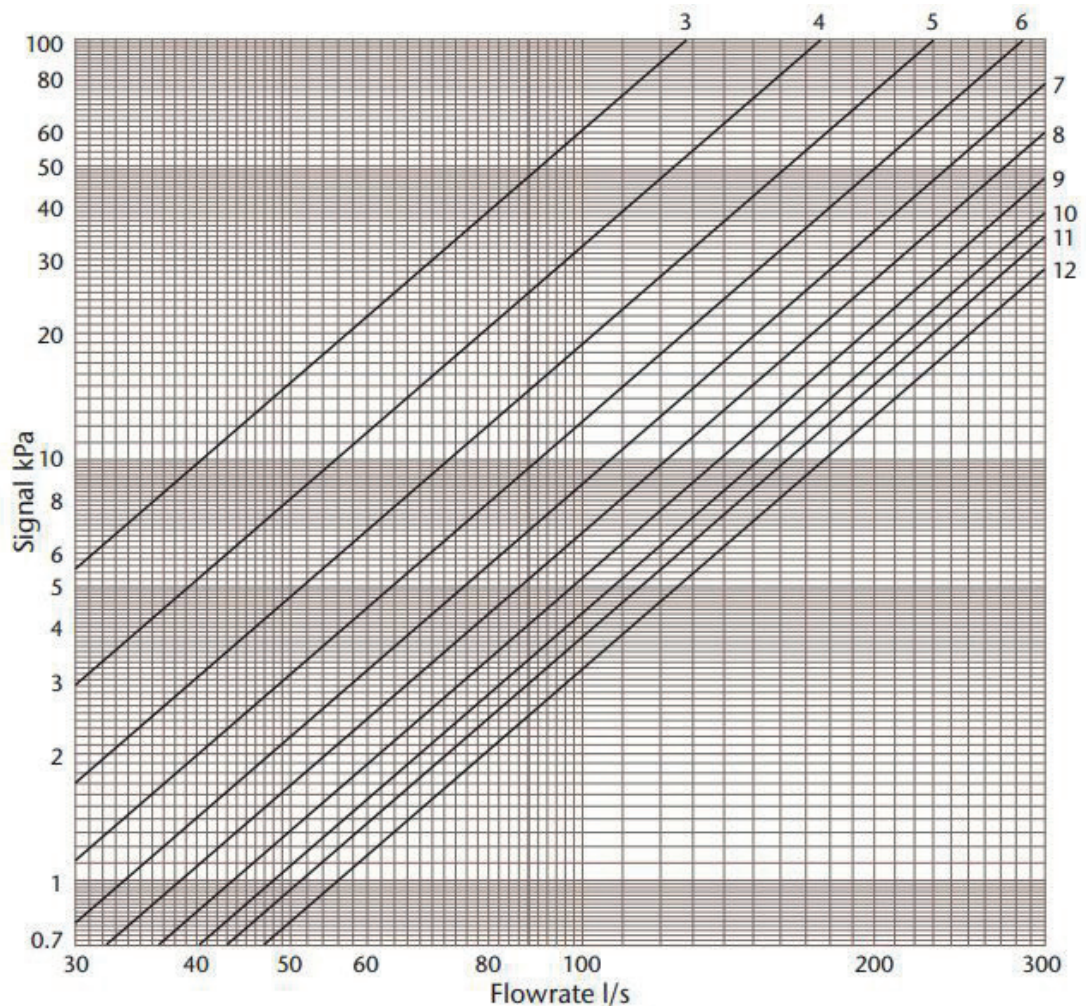

Position	3	4	5	6	7	8	9	10	11	12
Kvs	462	633	830	1025	1215	1393	1575	1730	1850	2022

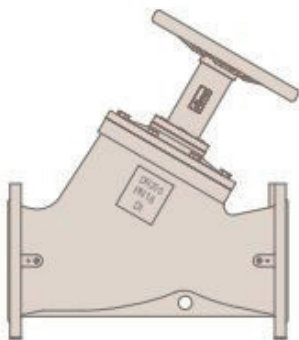

Signal / Flowrate

Chart used to determine flowrate from signal measured across orifice

$$Q = \frac{Kvs \sqrt{\Delta p}}{36}$$

Where

Q = Flowrate l/s

Δp = Signal kPa

Kvs = Signal Co-efficient



About Albion Valves (UK) Ltd

Albion has been supplying valves and fittings to the building services and industrial markets for the past 40 years.

Albion was created with the sole purpose of providing quality products at an affordable price. With a growing reputation for quality and reliability, Albion is now an established brand providing the industry with a trusted alternative to premium-priced products.

Our commitment to setting the highest standards in all areas of our business means, if you're looking for quality, service, delivery and choice — you'll find it's all at Albion.

Quality

Whatever you need, you can rest assured that if it comes from Albion it has been designed and manufactured to deliver optimum performance and is accredited with the necessary approvals. Our in-house quality department are always on hand too!

Service

We pride ourselves on our customer service – we have even won awards for it! Our cradle to grave approach means you will never be on your own!

Delivery

We know that time is money, and when a priority project depends on a part you can trust Albion to deliver – next day for all orders placed before 4:00PM.

Choice

We may have started out with a single brass ball valve, but our range has grown substantially since and we now consider ourselves to be a 'One Stop Shop' with our comprehensive range. It is becoming more and more apparent to the industry, that it really is all at Albion.