

ART 678

Gunmetal Pressure Reducing Valve



Features

- Standard threaded connections:
 - Male thread BSPT (ISO 7/1)
- Suitable for liquids
- BS EN 1567, ISO 3822, PED 2014/68/EU, PESR 2016
- Test certificate to EN10204-3.1 available on request
- Also available in Stainless Steel - ART 478

Technical data

Standard Version

Maximum Inlet pressure: 16 Bar

Outlet pressure: 1.5 - 7.0 Bar

Other Outlet Pressures Available

Low Pressure: 0.5 - 3.0 Bar

High Pressure: 3.0 - 12.0 Bar

Working temp: EPDM Seal
+5°C to +40°C

It is recommended that a reduction ratio no greater than 5:1 is achieved to avoid the risk of cavitation.

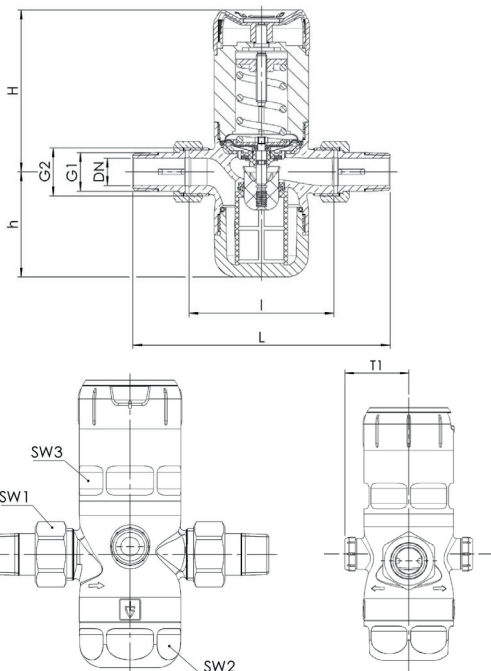

Connection	DN	1/2"	3/4"	1"	1 1/4"	1 1/2"	2"
Inlet pressure SP	bar	16	16	16	16	16	16
Outlet pressure SP	bar	1.5 - 7.0	1.5 - 7.0	1.5 - 7.0	1.5 - 7.0	1.5 - 7.0	1.5 - 7.0
Installation dimensions in mm	L	136	152	170	191	220	254
	l	80	90	100	105	130	140
	H	89	89	111	111	151	151
	h	58	58	64	64	94	94
	T1	37	37	46	46	50	50
	SW1	30	37	46	52	65	80
	SW2	46	46	66	66	75	75
	SW3	46	46	65	65	75	75
Weight	kg	0.8	0.9	1.7	1.9	3.9	4.5
Coefficient of flow kvs	m³/h	3.4	4.4	9.3	10.5	19.5	20.5

Part Name	Materials
Body	Gunmetal
Valve Insert	Plastic + EPDM
Filter Cup	Plastic
Filter Screen	Plastic
Spring Housing	Plastic PA Glass Fibre Reinforced
O-Rings	EPDM
Plugs	Plastic PA Glass Fibre Reinforced

Typical Applications

- Potable water supply
- Process water supply in industrial and building technology
- Machines / plants connected to the drinking water network
- Irrigation technology

Valve version

m with diaphragm High-quality, heat-resistant moulded elastomere, fabric-reinforced diaphragm.

Complete valve insert SP/HP (order code: 679 Insert-DN...-seal) available as replacement part can be exchanged without removing the valve.

Complete valve insert LP (order code: 679 LP Insert-DN...-seal) available as replacement part can be exchanged without removing the valve.

Built-in filter screen with 160µm mesh and made of stainless steel.

Medium

F Liquid For drinking water. Not suitable for steam. Other medium on request.

Type of lifting mechanism

O Without lifting device

Outlet pressure ranges

SP	Standard version	Inlet pressure: 16 Bar	Outlet pressure: from 1.5 to 7.0 bar
HP	High-pressure version	Inlet pressure: 16 Bar	Outlet pressure: from 3.0 to 12.0 bar
LP	Low-pressure version	Inlet pressure: 16 Bar	Outlet pressure: from 0.5 to 3.0 bar

Cavitation Chart

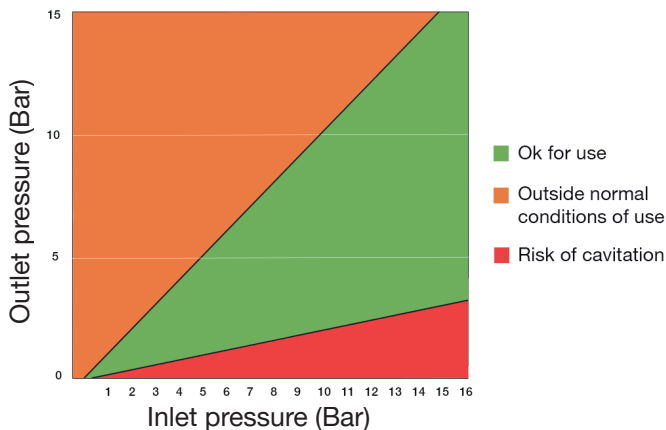

Capacity Charts

Dimensioning by pressure loss on the outlet pressure side

Flow chart water

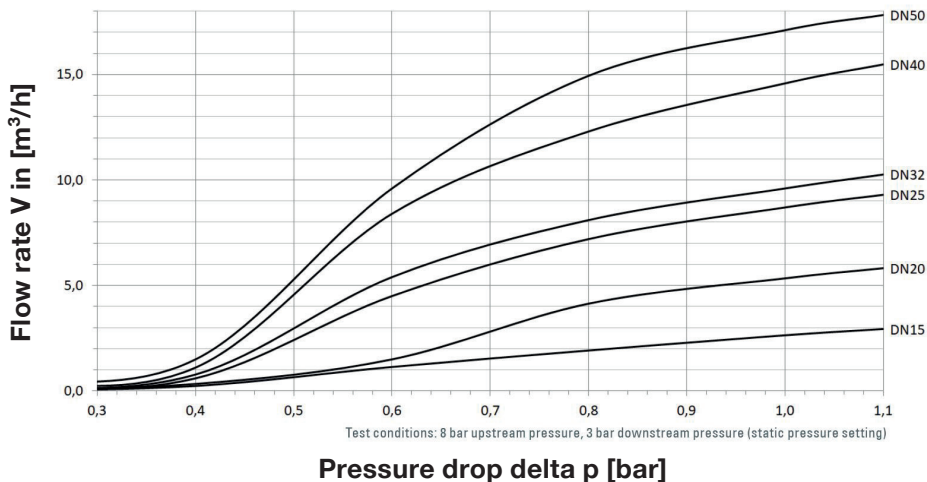

Dimensioning by flow velocity.

For liquids:

By using the chart you can determine the nominal diameter (DN) for a given flow volume V (m^3/h). According to the DVGW guidelines (DIN 1988) a flow velocity of 2m/s in domestic water supply systems should not be exceeded.

