

ART 1567

1/2" Angle Radiator Pack



Features

- 1/2" Angle Radiator TRV, Sensor Head & Lock shield pack
- Includes ART 1597, ART 1561, ART 1553 & 2x ART 1504. Refer to the relevant datasheets for full details about each component.
- Screwed BSP Parallel M/F threads (ISO 228/1) with Auto Seal Tail Piece
- Conforms to EN215 & suitable for use with all radiators
- Liquid Filled Sensor & TRV both have standard M30 x1.5 connection
- ART 1597 locking ring Temperature set-point lock & limit function

Technical data

Max pressure: 10 Bar
 Max working temp: 100°C

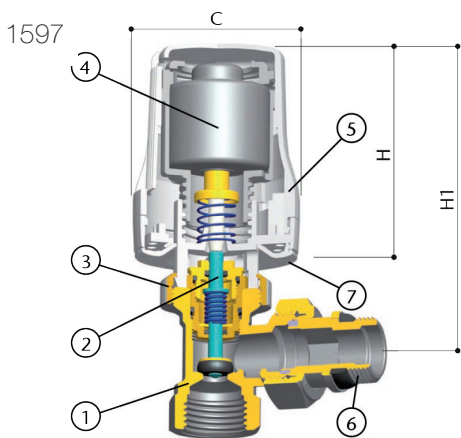

1561

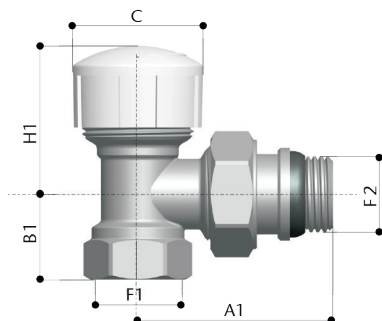

1537

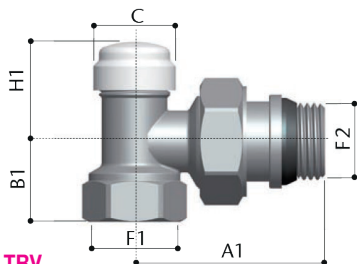

DN 1/2"	TRV	L/S	Sensor	Sensor / TRV Height
A	53.5	49.5		
B	27.5	23		
H	45	32	76.5	
A1	52	51		
B1	23	21.5		
H1	40	26		97
C	35	22	51	
F1	1/2	1/2		
F2	1/2	1/2		

V2. Dimensions in mm

This data sheet is designed as a guide and should not be regarded as wholly accurate in every detail. We reserve the right to amend the specification of any product without notice.